

⚠️ ENSURE FIREARM IS UNLOADED

⚠️ **WARNING:** Over-torquing fasteners can damage your mount and will not be covered by warranty.

NOTE: Do not adjust Pivot Bolt or disassemble mount. Doing so will void warranty

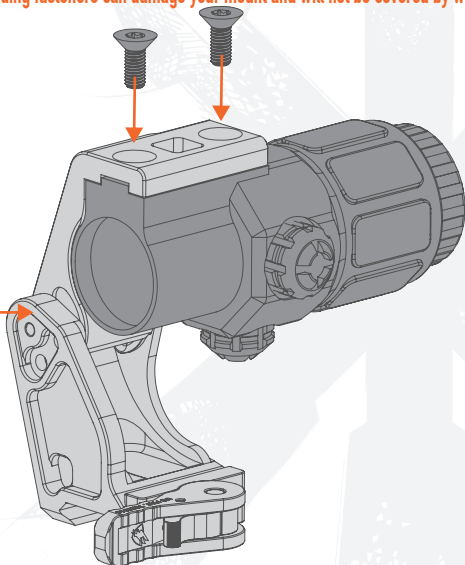

1 Remove EOTech™ G33 Magnifier from factory mount and set it aside.

2 Up-end and seat G33 Magnifier in FAST mount arm (do not use shim from OEM magnifier kit). Insert included screws. Secure screws using a T20 bit driver. Lightly snug all screws before applying final torque to any. **TORQUE TO 35 IN-LBS.**

⚠ ENSURE FIREARM IS UNLOADED

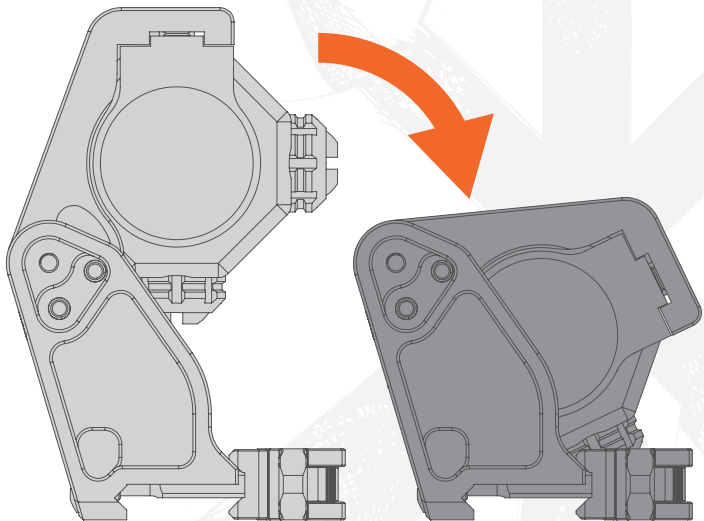

- 3** FAST Magnifier Mounts use a Force-to-Overcome mechanism.
- 4** Grasp magnifier body and pivot assembly down to stow position. Repeat in reverse to bring magnifier back into active position.